

ALLOY WHEELS ACCESSORIES

DECEMBER
2023

SPIGOT RINGS
WHEELS CENTER CAPS
3D DOMED POLYMER STICKERS
BOLTS AND NUTS

www.autoremia.it



 **WEBAUTO.LT**

PLASTIC SPIGOT RINGS FOR ALLOY WHEELS

Nr.	Code	Dimensions
1	CR-1076	54.1mm - 52.1mm
2	CR-1077	56.1mm - 52.1mm
3	CR-1053	56.1mm - 54.1mm
4	CR-1056	56.6mm - 54.1mm
5	CR-1078	57.1mm - 52.1mm
6	CR-1001	57.1mm - 54.1mm
7	CR-1064	57.1mm - 56.1mm
8	CR-1107	58.1mm - 54.1mm
9	CR-1113	58.1mm - 56.6mm
10	CR-1065	58.6mm - 54.1mm
11	CR-1066	58.6mm - 56.1mm
12	CR-1067	58.6mm - 56.6mm
13	CR-1068	58.6mm - 57.1mm
14	CR-1101	59.1mm - 54.1mm
15	CR-1042	60.0mm - 56.6mm
16	CR-1079	60.1mm - 52.1mm
17	CR-1002	60.1mm - 54.1mm
18	CR-1027	60.1mm - 56.1mm
19	CR-1104	60.1mm - 56.6mm
20	CR-1003	60.1mm - 57.1mm
21	CR-1063	60.1mm - 58.1mm
22	CR-1070	60.1mm - 58.6mm
23	CR-1043	63.3mm - 54.1mm
24	CR-1044	63.3mm - 56.1mm
25	CR-1045	63.3mm - 56.6mm
26	CR-1004	63.3mm - 57.0mm
27	CR-1028	63.3mm - 57.1mm
28	CR-1047	63.3mm - 58.1mm
29	CR-1071	63.3mm - 58.6mm
30	CR-1048	63.3mm - 59.1mm
31	CR-1005	63.3mm - 60.2mm
32	CR-1038	63.4mm - 54.1mm
33	CR-1601	63.4mm - 56.1mm
34	CR-1602	63.4mm - 56.6mm
35	CR-1603	63.4mm - 57.1mm
36	CR-1604	63.4mm - 58.1mm
37	CR-1605	63.4mm - 59.1mm
38	CR-1049	64.0mm - 54.1mm
39	CR-1031	64.0mm - 56.1mm
40	CR-1046	64.0mm - 56.6mm
41	CR-1114	64.0mm - 57.1mm
42	CR-1074	64.0mm - 58.1mm
43	CR-1075	64.0mm - 58.6mm
44	CR-1606	64.0mm - 59.1mm
45	CR-1006	64.0mm - 60.1mm
46	CR-1007	64.1mm - 57.1mm
47	CR-1081	64.1mm - 59.1mm
48	CR-1257	64.1mm - 60.1mm
49	CR-1008	65.0mm - 54.0mm
50	CR-1009	65.0mm - 56.0mm
51	CR-1010	65.0mm - 57.6mm
52	CR-1029	65.0mm - 57.1mm
53	CR-1011	65.0mm - 58.1mm
54	CR-1012	65.0mm - 58.6mm
55	CR-1030	65.0mm - 60.0mm
56	CR-1072	65.0mm - 64.1mm
57	CR-1080	65.1mm - 56.1mm
58	CR-1032	65.1mm - 63.3mm
59	CR-1112	65.1mm - 63.4mm
60	CR-1102	66.1mm - 54.1mm
61	CR-1082	66.1mm - 56.1mm
62	CR-1106	66.1mm - 56.6mm
63	CR-1083	66.1mm - 57.1mm
64	CR-1109	66.1mm - 58.1mm
65	CR-1110	66.1mm - 58.6mm
66	CR-1059	66.1mm - 60.1mm
67	CR-1103	66.1mm - 63.4mm
68	CR-1069	66.1mm - 64.1mm
69	CR-1108	66.45mm - 57.1mm
70	CR-1084	66.6mm - 54.1mm
71	CR-1085	66.6mm - 56.1mm
72	CR-1054	66.6mm - 56.6mm
73	CR-1013	66.6mm - 57.1mm
74	CR-1086	66.6mm - 58.1mm
75	CR-1111	66.6mm - 58.6mm
76	CR-1087	66.6mm - 59.1mm
77	CR-1088	66.6mm - 60.1mm
78	CR-1089	66.6mm - 63.3mm
79	CR-1090	66.6mm - 64.1mm
80	CR-1091	66.6mm - 65.1mm
81	CR-1057	67.1mm - 52.1mm
82	CR-1014	67.1mm - 54.1mm
83	CR-1015	67.1mm - 56.1mm
84	CR-1016	67.1mm - 56.6mm
85	CR-1017	67.1mm - 57.1mm
86	CR-1018	67.1mm - 58.1mm
87	CR-1055	67.1mm - 58.6mm
88	CR-1039	67.1mm - 59.1mm
89	CR-1019	67.1mm - 60.1mm
90	CR-1105	67.1mm - 63.3mm
91	CR-1020	67.1mm - 63.4mm
92	CR-1021	67.1mm - 64.1mm
93	CR-1040	67.1mm - 65.0mm
94	CR-1115	67.1mm - 65.1mm
95	CR-1050	67.1mm - 66.0mm
96	CR-1607	67.1mm - 66.1mm
97	CR-1116	68.0mm - 52.1mm
98	CR-1117	68.0mm - 54.1mm
99	CR-1118	68.0mm - 56.1mm
100	CR-1060	68.0mm - 56.6mm

Nr.	Code	Dimensions
101	CR-1061	68.0mm - 57.1mm
102	CR-1119	68.0mm - 58.1mm
103	CR-1120	68.0mm - 59.1mm
104	CR-1062	68.0mm - 60.1mm
105	CR-1092	68.1mm - 54.1mm
106	CR-1093	68.1mm - 56.1mm
107	CR-1094	68.1mm - 58.1mm
108	CR-1095	68.1mm - 59.1mm
109	CR-1096	68.1mm - 63.4mm
110	CR-1097	68.1mm - 64.1mm
111	CR-1098	68.1mm - 65.1mm
112	CR-1099	68.1mm - 66.1mm
113	CR-1100	68.1mm - 66.6mm
114	CR-1022	69.1mm - 54.1mm
115	CR-1023	69.1mm - 56.1mm
116	CR-1033	69.1mm - 56.6mm
117	CR-1024	69.1mm - 57.1mm
118	CR-1034	69.1mm - 58.1mm
119	CR-1058	69.1mm - 58.6mm
120	CR-1051	69.1mm - 59.1mm
121	CR-1035	69.1mm - 60.1mm
122	CR-1025	69.1mm - 63.3mm
123	CR-1036	69.1mm - 64.1mm
124	CR-1041	69.1mm - 65.1mm
125	CR-1026	69.1mm - 66.1mm
126	CR-1052	69.1mm - 66.6mm
127	CR-1037	69.1mm - 67.1mm
128	CR-1230	70.0mm - 56.6mm
129	CR-1201	70.0mm - 57.1mm
130	CR-1202	70.0mm - 58.6mm
131	CR-1203	70.0mm - 60.0mm
132	CR-1204	70.0mm - 63.3mm
133	CR-1205	70.0mm - 65.0mm
134	CR-1206	70.0mm - 66.1mm
135	CR-1207	70.0mm - 66.6mm
136	CR-1208	70.0mm - 67.1mm
137	CR-1231	70.1mm - 54.1mm
138	CR-1234	70.1mm - 56.1mm
139	CR-1240	70.1mm - 57.1mm
140	CR-1237	70.1mm - 58.1mm
141	CR-1239	70.1mm - 59.1mm
142	CR-1228	70.1mm - 60.1mm
143	CR-1214	70.1mm - 63.4mm
144	CR-1218	70.1mm - 64.0mm
145	CR-1222	70.1mm - 64.1mm
146	CR-1209	70.1mm - 65.0mm
147	CR-1252	70.1mm - 65.1mm
148	CR-1210	70.1mm - 66.0mm
149	CR-1253	70.1mm - 66.5mm
150	CR-1226	70.1mm - 66.6mm
151	CR-1213	70.1mm - 67.1mm
152	CR-1241	70.4mm - 54.1mm
153	CR-1242	70.4mm - 56.1mm
154	CR-1215	70.4mm - 56.6mm
155	CR-1216	70.4mm - 57.1mm
156	CR-1217	70.4mm - 60.1mm
157	CR-1243	70.4mm - 63.4mm
158	CR-1244	70.4mm - 65.1mm
159	CR-1254	70.4mm - 66.5mm
160	CR-1245	70.4mm - 66.6mm
161	CR-1246	70.6mm - 57.1mm
162	CR-1249	70.6mm - 60.1mm
163	CR-1250	70.6mm - 64.1mm
164	CR-1251	70.6mm - 66.1mm
165	CR-1255	70.6mm - 66.5mm
166	CR-1248	71.1mm - 65.1mm
167	CR-1211	71.5mm - 60.0mm
168	CR-1212	71.5mm - 66.5mm
169	CR-1227	71.5mm - 67.1mm
170	CR-1229	71.6mm - 54.1mm
171	CR-1219	71.6mm - 56.0mm
172	CR-1247	71.6mm - 56.6mm
173	CR-1221	71.6mm - 57.1mm
174	CR-1232	71.6mm - 58.6mm
175	CR-1223	71.6mm - 60.1mm
176	CR-1233	71.6mm - 63.4mm
177	CR-1224	71.6mm - 64.1mm
178	CR-1235	71.6mm - 65.1mm
179	CR-1225	71.6mm - 66.1mm
180	CR-1256	71.6mm - 66.5mm
181	CR-1238	71.6mm - 66.6mm
182	CR-1220	71.6mm - 67.1mm
183	CR-1236	71.6mm - 70.1mm
184	CR-1355	72.0mm - 52.1mm
185	CR-1312	72.0mm - 54.0mm
186	CR-1313	72.0mm - 56.1mm
187	CR-1322	72.0mm - 56.6mm
188	CR-1301	72.0mm - 57.1mm
189	CR-1350	72.0mm - 58.1mm
190	CR-1319	72.0mm - 58.6mm
191	CR-1353	72.0mm - 59.1mm
192	CR-1354	72.0mm - 59.6mm
193	CR-1323	72.0mm - 60.1mm
194	CR-1314	72.0mm - 63.4mm
195	CR-1316	72.0mm - 64.1mm
196	CR-1351	72.0mm - 65.1mm
197	CR-1317	72.0mm - 66.1mm
198	CR-1324	72.0mm - 66.6mm
199	CR-1315	72.0mm - 67.1mm
200	CR-1326	72.3mm - 57.1mm

Nr.	Code	Dimensions
201	CR-1327	72.3mm - 60.1mm
202	CR-1328	72.3mm - 66.6mm
203	CR-1329	72.3mm - 67.1mm
204	CR-1330	72.3mm - 70.1mm
205	CR-1356	72.5mm - 56.6mm
206	CR-1357	72.5mm - 57.1mm
207	CR-1358	72.5mm - 58.1mm
208	CR-1359	72.5mm - 58.6mm
209	CR-1360	72.5mm - 59.1mm
210	CR-1361	72.5mm - 59.6mm
211	CR-1362	72.5mm - 60.1mm
212	CR-1363	72.5mm - 63.4mm
213	CR-1364	72.5mm - 64.1mm
214	CR-1365	72.5mm - 65.1mm
215	CR-1366	72.5mm - 66.1mm
216	CR-1367	72.5mm - 66.6mm
217	CR-1368	72.5mm - 67.1mm
218	CR-1369	72.5mm - 69.1mm
219	CR-1370	72.5mm - 70.1mm
220	CR-1371	72.5mm - 70.5mm
221	CR-1352	72.6mm - 54.1mm
222	CR-1318	72.6mm - 56.1mm
223	CR-1325	72.6mm - 56.6mm
224	CR-1302	72.6mm - 57.1mm
225	CR-1306	72.6mm - 58.1mm
226	CR-1307	72.6mm - 58.6mm
227	CR-1320	72.6mm - 59.1mm
228	CR-1608	72.6mm - 59.2mm
229	CR-1609	72.6mm - 59.6mm
230	CR-1305	72.6mm - 60.1mm
231	CR-1310	72.6mm - 63.3mm
232	CR-1610	72.6mm - 63.4mm
233	CR-1611	72.6mm - 63.9mm
234	CR-1311	72.6mm - 64.1mm
235	CR-1303	72.6mm - 65.1mm
236	CR-1308	72.6mm - 66.1mm
237	CR-1304	72.6mm - 66.5mm
238	CR-1612	72.6mm - 66.6mm
239	CR-1309	72.6mm - 67.1mm
240	CR-1321	72.6mm - 70.1mm
241	CR-1613	72.6mm - 70.3mm
242	CR-1614	72.6mm - 70.5mm
243	CR-1372	72.6mm - 71.1mm
244	CR-1373	72.6mm - 71.6mm
245	CR-1401	73.1mm - 54.1mm
246	CR-1402	73.1mm - 56.1mm
247	CR-1403	73.1mm - 56.6mm
248	CR-1404	73.1mm - 57.1mm
249	CR-1405	73.1mm - 58.1mm
250	CR-1464	73.1mm - 58.6mm
251	CR-1615	73.1mm - 58.8mm
252	CR-1415	73.1mm - 59.1mm
253	CR-1437	73.1mm - 59.6mm
254	CR-1406	73.1mm - 60.1mm
255	CR-1407	73.1mm - 63.3mm
256	CR-1479	73.1mm - 63.4mm
257	CR-1616	73.1mm - 63.5mm
258	CR-1617	73.1mm - 63.9mm
259	CR-1408	73.1mm - 64.1mm
260	CR-1409	73.1mm - 65.1mm
261	CR-1410	73.1mm - 66.1mm
262	CR-1423	73.1mm - 66.5mm
263	CR-1411	73.1mm - 66.6mm
264	CR-1412	73.1mm - 67.1mm
265	CR-1424	73.1mm - 69.1mm
266	CR-1417	73.1mm - 70.0mm
267	CR-1618	73.1mm - 70.1mm
268	CR-1422	73.1mm - 70.2mm
269	CR-1619	73.1mm - 70.3mm
270	CR-1620	73.1mm - 70.5mm
271	CR-1448	73.1mm - 70.6mm
272	CR-1438	73.1mm - 71.1mm
273	CR-1621	73.1mm - 71.5mm
274	CR-1416	73.1mm - 71.6mm
275	CR-1480	73.1mm - 72.0mm
276	CR-1622	74.0mm - 54.1mm
277	CR-1623	74.0mm - 56.1mm
278	CR-1624	74.0mm - 56.6mm
279	CR-1625	74.0mm - 57.1mm
280	CR-1626	74.0mm - 58.1mm
281	CR-1627	74.0mm - 59.1mm
282	CR-1628	74.0mm - 60.1mm
283	CR-1629	74.0mm - 63.4mm
284	CR-1630	74.0mm - 63.9mm
285	CR-1631	74.0mm - 64.1mm
286	CR-1632	74.0mm - 65.1mm
287	CR-1633	74.0mm - 66.1mm
288	CR-1634	74.0mm - 66.6mm
289	CR-1635	74.0mm - 67.1mm
290	CR-1636	74.0mm - 70.1mm
291	CR-1637	74.0mm - 70.3mm
292	CR-1638	74.0mm - 71.5mm
293	CR-1639	74.0mm - 72.6mm
294	CR-1467	74.1mm - 54.1mm
295	CR-1468	74.1mm - 56.1mm
296	CR-1469	74.1mm - 56.6mm
297	CR-1418	74.1mm - 57.1mm
298	CR-1470	7

PLASTIC SPIGOT RINGS FOR ALLOY WHEELS

Spigot rings for MOMO wheels

Nr.	Code	Dimensions
471	CR-1374	72.0mm - 57.1/6mm
472	CR-1375	72.2mm - 57.1/6mm
473	CR-1331	72.3mm - 57.1/6mm
474	CR-1332	72.3mm - 60.1/6mm
475	CR-1333	72.3mm - 64.1/6mm
476	CR-1334	72.3mm - 66.5/6mm
477	CR-1335	72.3mm - 66.6/6mm
478	CR-1336	79.5mm - 72.6/6mm
479	CR-1490	76.0mm - 64.1/8mm
480	CR-1519	72.3mm - 67.1/6mm
481	CR-1520	79.5mm - 74.1/6mm
482	CR-1529	79.6mm - 57.1/6mm

ALUMINUM SPIGOT RINGS

Nr.	Code	Dimensions
1	CR-8101	60.1mm - 54.1mm
2	CR-8102	60.1mm - 56.1mm
3	CR-8103	60.1mm - 56.6mm
4	CR-8104	60.1mm - 57.1mm
5	CR-8105	60.1mm - 58.1mm
6	CR-8106	63.4mm - 54.1mm
7	CR-8107	63.4mm - 56.1mm
8	CR-8108	63.4mm - 56.6mm
9	CR-8109	63.4mm - 57.1mm
10	CR-8110	63.4mm - 58.1mm
11	CR-8111	63.4mm - 59.1mm
12	CR-8112	64.0mm - 54.1mm
13	CR-8113	64.0mm - 56.1mm
14	CR-8114	64.0mm - 56.6mm
15	CR-8115	64.0mm - 57.1mm
16	CR-8116	64.0mm - 58.1mm
17	CR-8117	64.0mm - 59.1mm
18	CR-8118	64.0mm - 60.1mm

Nr.	Code	Dimensions
19	CR-8119	65.1mm - 63.4mm
20	CR-8120	66.6mm - 57.1mm
21	CR-8121	67.1mm - 54.1mm
22	CR-8122	67.1mm - 56.1mm
23	CR-8123	67.1mm - 56.6mm
24	CR-8124	67.1mm - 57.1mm
25	CR-8125	67.1mm - 58.1mm
26	CR-8126	67.1mm - 58.6mm
27	CR-8127	67.1mm - 60.1mm
28	CR-8128	67.1mm - 63.4mm
29	CR-8129	67.1mm - 64.1mm
30	CR-8130	67.1mm - 66.1mm
31	CR-8131	72.6mm - 54.1mm
32	CR-8132	72.6mm - 56.1mm
33	CR-8133	72.6mm - 56.6mm
34	CR-8134	72.6mm - 57.1mm
35	CR-8135	72.6mm - 59.2mm
36	CR-8136	72.6mm - 59.6mm

Nr.	Code	Dimensions
37	CR-8137	72.6mm - 60.1mm
38	CR-8138	72.6mm - 63.4mm
39	CR-8139	72.6mm - 63.9mm
40	CR-8140	72.6mm - 64.1mm
41	CR-8141	72.6mm - 65.1mm
42	CR-8142	72.6mm - 66.1mm
43	CR-8143	72.6mm - 66.6mm
44	CR-8144	72.6mm - 67.1mm
45	CR-8145	72.6mm - 70.1mm
46	CR-8146	72.6mm - 70.3mm
47	CR-8147	72.6mm - 70.5mm
48	CR-8148	73.1mm - 54.1mm
49	CR-8149	73.1mm - 56.1mm
50	CR-8150	73.1mm - 56.6mm
51	CR-8151	73.1mm - 57.1mm
52	CR-8152	73.1mm - 58.1mm
53	CR-8153	73.1mm - 58.8mm
54	CR-8154	73.1mm - 59.1mm

Nr.	Code	Dimensions
55	CR-8155	73.1mm - 59.6mm
56	CR-8156	73.1mm - 60.1mm
57	CR-8157	73.1mm - 63.4mm
58	CR-8158	73.1mm - 63.5mm
59	CR-8159	73.1mm - 63.9mm
60	CR-8160	73.1mm - 64.1mm
61	CR-8161	73.1mm - 65.1mm
62	CR-8162	73.1mm - 66.1mm
63	CR-8163	73.1mm - 66.6mm
64	CR-8164	73.1mm - 67.1mm
65	CR-8165	73.1mm - 70.1mm
66	CR-8166	73.1mm - 70.3mm
67	CR-8167	73.1mm - 70.5mm
68	CR-8168	73.1mm - 71.5mm
69	CR-8169	74.0mm - 54.1mm
70	CR-8170	74.0mm - 56.1mm
71	CR-8171	74.0mm - 56.6mm
72	CR-8172	74.0mm - 57.1mm

Nr.	Code	Dimensions
73	CR-8173	74.0mm - 58.1mm
74	CR-8174	74.0mm - 59.1mm
75	CR-8175	74.0mm - 60.1mm
76	CR-8176	74.0mm - 63.4mm
77	CR-8177	74.0mm - 63.9mm
78	CR-8178	74.0mm - 64.1mm
79	CR-8179	74.0mm - 65.1mm
80	CR-8180	74.0mm - 66.1mm
81	CR-8181	74.0mm - 66.6mm
82	CR-8182	74.0mm - 67.1mm
83	CR-8183	74.0mm - 70.1mm
84	CR-8184	74.0mm - 70.3mm
85	CR-8185	74.0mm - 71.5mm
86	CR-8186	74.0mm - 72.6mm



ALUMINUM SPIGOT RINGS FOR BBS WHEELS

Nr.	Code	Dimensions	OEM	Description
1	CR-8001	70.0 mm	09.23.409	Spring / Retaining Ring
2	CR-8002	82.0 mm	09.23.415	Spring / Retaining Ring
3	CR-8003	70.0 mm - 54.0 mm	09.23.404	Suzuki / Opel / Saab / Kia / Mazda / Toyota
4	CR-8004	70.0 mm - 56.0 mm	09.23.405	Subaru / Honda / Mitsubishi / Kia / Daihatsu / Mini
5	CR-8005	70.0 mm - 56.5 mm	09.23.406	Daewoo / Opel
6	CR-8006	70.0 mm - 57.0 mm	09.23.411	Audi / VW / Seat / Skoda / Chrysler
7	CR-8007	70.0 mm - 58.0 mm	09.23.431	Alfa / Fiat / Lancia / Chrysler
8	CR-8008	70.0 mm - 58.5 mm	09.23.432	Alfa / Skoda
9	CR-8009	70.0 mm - 59.0 mm	09.23.407	Nissan / Alfa
10	CR-8010	70.0 mm - 60.0 mm	09.23.408	Renault / Nissan
11	CR-8011	70.0 mm - 63.3 mm	09.23.455	Ford / Mazda
12	CR-8012	70.0 mm - 65.0 mm	09.23.456	Citroen / Peugeot / Volvo / Rover
13	CR-8013	82.0 mm - 57.0 mm	09.23.585	VW / Audi / Seat / Skoda / Ford
14	CR-8014	82.0 mm - 59.5 mm	09.23.443	Mazda
15	CR-8015	82.0 mm - 60.0 mm	09.23.412	Toyota / Suzuki / Fiat
16	CR-8016	82.0 mm - 64.0 mm	09.23.433	Mitsubishi / Honda / Rover
17	CR-8017	82.0 mm - 65.0 mm	09.23.558	Opel / Saab / VW / Alfa Peugeot
18	CR-8018	82.0 mm - 66.0 mm	09.23.413	Mercedes Benz / Nissan / Renault / Dacia
19	CR-8019	82.0 mm - 66.5 mm	09.23.607	Audi / Mercedes Benz
20	CR-8020	82.0 mm - 67.0 mm	09.23.414	Opel / Ford / Mazda / Mitsubishi
21	CR-8021	82.0 mm - 70.0 mm	09.23.420	Honda / Land Rover
22	CR-8022	82.0 mm - 70.7 mm	09.23.462	
23	CR-8023	82.0 mm - 71.4 mm	09.23.421	Chrysler Voyager / Lancia / FIAT Freemont
24	CR-8024	82.0 mm - 71.5 mm	09.23.571	Chrysler / Jeep / Dodge
25	CR-8025	82.0 mm - 72.5 mm	09.23.490	BMW / Land Rover
26	CR-8026	82.0 mm - 74.1 mm	09.23.491	BMW



The actual appearance of the product may sometimes differ from the image.
The delivered goods are spare parts. The names of cars and original numbers are for information purposes only.

SPIGOT RINGS FOR ALLOY WHEELS

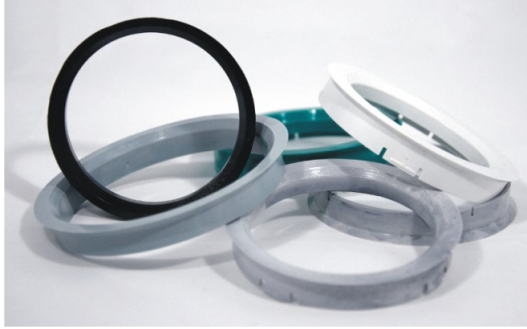

Material: Polycarbonate (PC) - is a polymer, which distinguished by its extremely high impact resistance, even at low temperatures, mechanical strength, good dielectric properties, etc.



Package: 4 pcs.
transparent PP bag with euro hanger

Why you should use spigot rings?

Do you have vibration problems on your newly balanced after market wheels? No problem, we have a solution! Improve the fitment & balance of your aftermarket wheels with hub centric rings!

Spigot Rings or Alloy Wheel Hub Centric Rings are designed to fill in the gap between the hub of the car and the center bore of the wheel. Most wheel manufacturers design their wheels with a centerbore large enough to fit on most cars. Therefore, since wheel manufactures make their center bore large enough to fit most cars, most wheel fitments have a gap between the hub and the centerbore.

This gap usually doesn't allow for the wheel to fit hubcentric but rather lugcentric which causes vibration. Therefore, to fill the gap and ensure the fitment is hubcentric, hub rings are used.

Alloy Wheel Spigot Rings are used to ensure that an alloy wheel is centred correctly on a hub of a vehicle. This is very important to ensure that your alloy wheels are safe and secure.

It is dangerous to use alloy wheels which do not have the correct Spigot Rings specified for your car.

Our hub centric rings are made of high quality Poly Carbon. The Poly Carbon material acts like spigot ring eliminating corrosion which is a common problem with aluminum hub centric rings.

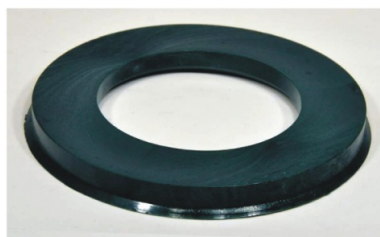
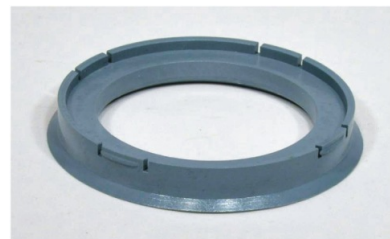

The actual appearance of the product may sometimes differ from the image.
The delivered goods are spare parts. The names of cars and original numbers are for information purposes only.

WHEELS CENTER CAPS

Nr.	Code	Outside diameter Ø (mm)	Rim hole diameter Ø (mm)	Sticker diameter Ø (mm)	Fixing length (mm)	Length up to fixing (mm)
1	RD-1201	147.0	57.0	120.0	19.0	11.0
2	RD-1203	147.0	57.5	120.0	26.0	18.0
3	RD-1204	155.0	57.5	64.0	13.0	2.5
4	RD-1205	130.0	59.0	58.0	11.0	6.0
5	RD-1207	113.0	99.5	-	11.0	5.0
6	RD-1208	167.0	149.5	132.0	18.0	8.5
7	RD-1209	130.0	59.0	58.0	11.0	6.0
8	RD-1210	130.0	68.0	-	34.0	4.0
9	RD-1211	110.0	65.0	59.0	12.0	6.5
10	RD-1212	165.0	137.0	140.0	17.0	10.0
11	RD-1213	150.0	142.0	-	12.0	10.0
12	RD-1214	155.0	58.0	90.0	22.0	18.0
13	RD-1215	115.0	82.0	60.0	33.0	27.0
14	RD-1216	165.0	58.0	90.0	18.0	13.0
15	RD-1217	147.0	58.0	-	18.0	9.0
16	RD-1218	147.0	60.0	65.0	14.0	6.0
17	RD-1219	139.0	58.0	-	20.0	11.0
18	RD-1220	148.0	58.0	-	14.0	9.0
19	RD-1221	152.0	58.0	90.0	23.0	15.0
20	RD-1222	156.0	112.0	94.0	15.0	6.0
21	RD-1223	140.0	60.0	-	13.5	6.0
22	RD-1224	125.0	60.0	-	14.5	6.0
23	RD-1225	146.0	57.5	-	15.5	7.0
24	RD-5001	50.0	43.0	49.0	13.0	8.5
25	RD-5101	59.0	55.0	51.0	9.5	5.0
26	RD-5102	59.5	55.0	-	9.0	5.0
27	RD-5401	54.0	49.5	53.0	8.5	3.0
28	RD-5402	54.0	47.0	53.0	13.5	7.5
29	RD-5501	55.0	50.0	54.0	9.0	3.5
30	RD-5502	55.0	49.5	54.0	10.5	4.5
31	RD-5503	54.5	50.0	53.0	13.5	6.5
32	RD-5601	56.0	51.5	55.0	10.0	4.5
33	RD-5602	55.5	51.5	55.0	7.0	3.0
34	RD-5603	55.5	55.0	55.0	7.5	2.0
35	RD-5604	56.0	46.0	55.0	10.5	4.0
36	RD-5605	56.0	54.0	55.0	11.0	3.0
37	RD-5606	56.0	51.8	55.0	9.0	4.0
38	RD-5701	57.0	51.5	56.0	10.0	4.5
39	RD-5801	57.5	52.5	57.0	11.0	4.5
40	RD-5802	57.5	51.5	57.0	15.5	8.0
41	RD-5803	58.0	56.0	57.0	11.0	5.0
42	RD-5902	59.0	55.0	59.0	9.5	5.0
43	RD-5903	61.5	48.0	61.0	8.5	2.5
44	RD-6001	60.0	49.5	59.0	12.5	7.0
45	RD-6002	60.0	54.0	59.0	9.0	4.5
46	RD-6003	59.5	56.5	-	6.5	2.5
47	RD-6004	59.5	56.0	59.0	8.5	3.5
48	RD-6005	60.0	43.0	59.0	11.5	5.5
49	RD-6006	59.0	52.0	59.0	8.0	3.0
50	RD-6007	59.5	46.5	59.0	16.5	10.5
51	RD-6008	60.0	55.5	59.0	10.0	5.0
52	RD-6009	60.0	56.0	59.0	8.5	2.5
53	RD-6010	60.0	57.5	59.0	10.5	3.0
54	RD-6011	60.0	55.0	54.0	12.5	6.0
55	RD-6012	60.0	58.0	-	11.5	3.5
56	RD-6013	60.0	56.5	59.0	10.0	6.0
57	RD-6101	60.5	56.0	60.0	11.5	2.5
58	RD-6102	60.0	56.0	39.0	9.0	4.5
59	RD-6201	61.5	55.5	61.0	7.0	2.0
60	RD-6202	62.0	60.0	60.0	13.0	9.0
61	RD-6301	63.0	58.5	62.0	7.5	2.5
62	RD-6302	62.5	57.0	61.0	16.0	8.0
63	RD-6303	62.5	55.5	58.0	6.5	2.5
64	RD-6304	63.0	54.0	62.0	7.5	4.0
65	RD-6401	68.0	65.0	64.0	11.0	4.0
66	RD-6402	63.5	61.0	63.0	6.0	2.5
67	RD-6403	63.0	57.5	63.0	14.5	6.0
68	RD-6404	64.0	58.0	63.0	10.5	4.5
69	RD-6501	64.0	61.5	64.0	10.0	4.0
70	RD-6502	64.5	60.0	64.0	11.5	3.5
71	RD-6503	66.5	56.0	66.0	12.0	4.0
72	RD-6504	64.5	55.0	64.0	17.5	10.0
73	RD-6505	64.0	57.0	63.0	10.0	5.0
74	RD-6601	66.0	56.0	62.0	7.0	2.5
75	RD-6701	67.0	56.0	66.0	17.5	13.0
76	RD-6801	68.0	55.5	-	11.0	4.0
77	RD-6802	68.0	62.5	59.0	9.0	3.5
78	RD-6803	67.5	62.5	44.0	8.5	5.0
79	RD-7001	69.5	63.0	69.0	11.0	5.0
80	RD-7002	69.5	56.0	69.0	12.0	3.5
81	RD-7003	70.0	67.0	69.0	21.0	9.5
82	RD-7004	70.0	60.0	69.0	12.5	2.0
83	RD-7401	76.0	58.5	75.0	16.0	8.5
84	RD-7502	75.0	72.0	74.0	14.0	7.5
85	RD-7701	76.5	65.5	76.0	12.5	4.0

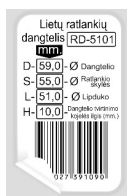

Alloy wheels caps with different
 barcoding
 (EAN barcodes)



Package: 4 pcs.
 transparent PP bag
 with euro hanger

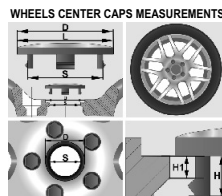

D - Outside diameter - Ø(mm)
 S - Rim hole diameter - Ø(mm)
 L - Sticker diameter - Ø(mm)
 H - Fixing length - (mm)
 H1 - Length up to fixing - (mm)

The actual appearance of the product may sometimes differ from the image.
 The delivered goods are spare parts. The names of cars and original numbers are for information purposes only.

WHEELS CENTER CAPS



RD-1201

Outside diameter - Ø(mm)	147.0
Rim hole diameter - Ø(mm)	57.0
Sticker diameter - Ø(mm)	120.0
Length up to fixing - (mm)	19.0
Fixing length - (mm)	11.0
EAN barcode	4779027391786



RD-1203

Outside diameter - Ø(mm)	147.0
Rim hole diameter - Ø(mm)	57.5
Sticker diameter - Ø(mm)	120.0
Length up to fixing - (mm)	26.0
Fixing length - (mm)	18.0
EAN barcode	4779027391946



RD-1204

Outside diameter - Ø(mm)	155.0
Rim hole diameter - Ø(mm)	57.5
Sticker diameter - Ø(mm)	64.0
Length up to fixing - (mm)	13.0
Fixing length - (mm)	2.5
EAN barcode	4779027391953



RD-1205

Outside diameter - Ø(mm)	130.0
Rim hole diameter - Ø(mm)	59.0
Sticker diameter - Ø(mm)	58.0
Length up to fixing - (mm)	11.0
Fixing length - (mm)	6.0
EAN barcode	4779035327180



RD-1207

Outside diameter - Ø(mm)	113.0
Rim hole diameter - Ø(mm)	99.5
Sticker diameter - Ø(mm)	-
Length up to fixing - (mm)	11.0
Fixing length - (mm)	5.0
EAN barcode	4779035325568



RD-1208

Outside diameter - Ø(mm)	167.0
Rim hole diameter - Ø(mm)	149.5
Sticker diameter - Ø(mm)	132.0
Length up to fixing - (mm)	18.0
Fixing length - (mm)	8.5
EAN barcode	4779035324530



RD-1209

Outside diameter - Ø(mm)	130.0
Rim hole diameter - Ø(mm)	59.0
Sticker diameter - Ø(mm)	58.0
Length up to fixing - (mm)	11.0
Fixing length - (mm)	6.0
EAN barcode	4779035325551



RD-1210

Outside diameter - Ø(mm)	130.0
Rim hole diameter - Ø(mm)	68.0
Sticker diameter - Ø(mm)	-
Length up to fixing - (mm)	34.0
Fixing length - (mm)	4.0
EAN barcode	4779035325827



RD-1211

Outside diameter - Ø(mm)	110.0
Rim hole diameter - Ø(mm)	65.0
Sticker diameter - Ø(mm)	59.0
Length up to fixing - (mm)	12.0
Fixing length - (mm)	6.5
EAN barcode	477903532600



RD-1212

Outside diameter - Ø(mm)	165.0
Rim hole diameter - Ø(mm)	137.0
Sticker diameter - Ø(mm)	140.0
Length up to fixing - (mm)	17.0
Fixing length - (mm)	10.0
EAN barcode	4779035326206



RD-1213

Outside diameter - Ø(mm)	150.0
Rim hole diameter - Ø(mm)	142.0
Sticker diameter - Ø(mm)	-
Length up to fixing - (mm)	12.0
Fixing length - (mm)	10.0
EAN barcode	4779035326213



RD-1214

Outside diameter - Ø(mm)	155.0
Rim hole diameter - Ø(mm)	58.0
Sticker diameter - Ø(mm)	90.0
Length up to fixing - (mm)	22.0
Fixing length - (mm)	18.0
EAN barcode	4779035326497

WHEELS CENTER CAPS



RD-1215

Outside diameter - Ø(mm)	115.0
Rim hole diameter - Ø(mm)	82.0
Sticker diameter - Ø(mm)	60.0
Length up to fixing - (mm)	33.0
Fixing length - (mm)	27.0
EAN barcode	4779035326503



RD-1216

Outside diameter - Ø(mm)	165.0
Rim hole diameter - Ø(mm)	58.0
Sticker diameter - Ø(mm)	90.0
Length up to fixing - (mm)	18.0
Fixing length - (mm)	13.0
EAN barcode	4779035326534



RD-1217

Outside diameter - Ø(mm)	147.0
Rim hole diameter - Ø(mm)	58.0
Sticker diameter - Ø(mm)	-
Length up to fixing - (mm)	18.0
Fixing length - (mm)	9.0
EAN barcode	4779035326572



RD-1218

Outside diameter - Ø(mm)	147.0
Rim hole diameter - Ø(mm)	60.0
Sticker diameter - Ø(mm)	65.0
Length up to fixing - (mm)	14.0
Fixing length - (mm)	6.0
EAN barcode	4779035326589



RD-1219

Outside diameter - Ø(mm)	139.0
Rim hole diameter - Ø(mm)	58.0
Sticker diameter - Ø(mm)	-
Length up to fixing - (mm)	20.0
Fixing length - (mm)	11.0
EAN barcode	4779035326596



RD-1220

Outside diameter - Ø(mm)	148.0
Rim hole diameter - Ø(mm)	58.0
Sticker diameter - Ø(mm)	-
Length up to fixing - (mm)	14.0
Fixing length - (mm)	9.0
EAN barcode	4779035326640



RD-1221

Outside diameter - Ø(mm)	152.0
Rim hole diameter - Ø(mm)	58.0
Sticker diameter - Ø(mm)	90.0
Length up to fixing - (mm)	23.0
Fixing length - (mm)	15.0
EAN barcode	4779035326718



RD-1222

Outside diameter - Ø(mm)	156.0
Rim hole diameter - Ø(mm)	112.0
Sticker diameter - Ø(mm)	94.0
Length up to fixing - (mm)	15.0
Fixing length - (mm)	6.0
EAN barcode	4779035326725



RD-1223

Outside diameter - Ø(mm)	140.0
Rim hole diameter - Ø(mm)	60.0
Sticker diameter - Ø(mm)	-
Length up to fixing - (mm)	13.5
Fixing length - (mm)	6.0
EAN barcode	4779035326886



RD-1224

Outside diameter - Ø(mm)	125.0
Rim hole diameter - Ø(mm)	60.0
Sticker diameter - Ø(mm)	-
Length up to fixing - (mm)	14.5
Fixing length - (mm)	6.0
EAN barcode	4779035327197



RD-1225

Outside diameter - Ø(mm)	146.0
Rim hole diameter - Ø(mm)	57.5
Sticker diameter - Ø(mm)	-
Length up to fixing - (mm)	15.5
Fixing length - (mm)	7.0
EAN barcode	4779035328200



RD-5001

Outside diameter - Ø(mm)	50.0
Rim hole diameter - Ø(mm)	43.0
Sticker diameter - Ø(mm)	49.0
Length up to fixing - (mm)	13.0
Fixing length - (mm)	8.5
EAN barcode	4779035328125

WHEELS CENTER CAPS



RD-5101

Outside diameter - Ø(mm)	59.0
Rim hole diameter - Ø(mm)	55.0
Sticker diameter - Ø(mm)	51.0
Length up to fixing - (mm)	9.5
Fixing length - (mm)	5.0
EAN barcode	4779027391793



RD-5102

Outside diameter - Ø(mm)	59.0
Rim hole diameter - Ø(mm)	55.0
Sticker diameter - Ø(mm)	-
Length up to fixing - (mm)	9.0
Fixing length - (mm)	5.0
EAN barcode	4779027391809



RD-5401

Outside diameter - Ø(mm)	54.0
Rim hole diameter - Ø(mm)	49.5
Sticker diameter - Ø(mm)	53.0
Length up to fixing - (mm)	8.5
Fixing length - (mm)	3.0
EAN barcode	4779027392554



RD-5402

Outside diameter - Ø(mm)	54.0
Rim hole diameter - Ø(mm)	47.0
Sticker diameter - Ø(mm)	53.0
Length up to fixing - (mm)	13.5
Fixing length - (mm)	7.5
EAN barcode	4779035326794



RD-5501

Outside diameter - Ø(mm)	55.0
Rim hole diameter - Ø(mm)	50.0
Sticker diameter - Ø(mm)	54.0
Length up to fixing - (mm)	9.0
Fixing length - (mm)	3.5
EAN barcode	4779027392431



RD-5502

Outside diameter - Ø(mm)	55.0
Rim hole diameter - Ø(mm)	49.5
Sticker diameter - Ø(mm)	54.0
Length up to fixing - (mm)	10.5
Fixing length - (mm)	4.5
EAN barcode	4779027392820



RD-5503

Outside diameter - Ø(mm)	54.5
Rim hole diameter - Ø(mm)	50.0
Sticker diameter - Ø(mm)	53.0
Length up to fixing - (mm)	13.5
Fixing length - (mm)	6.5
EAN barcode	4779035326800



RD-5601

Outside diameter - Ø(mm)	56.0
Rim hole diameter - Ø(mm)	51.5
Sticker diameter - Ø(mm)	55.0
Length up to fixing - (mm)	10.0
Fixing length - (mm)	4.5
EAN barcode	4779027391991



RD-5602

Outside diameter - Ø(mm)	55.5
Rim hole diameter - Ø(mm)	51.5
Sticker diameter - Ø(mm)	55.0
Length up to fixing - (mm)	7.0
Fixing length - (mm)	3.0
EAN barcode	4779027392509



RD-5603

Outside diameter - Ø(mm)	55.5
Rim hole diameter - Ø(mm)	55.0
Sticker diameter - Ø(mm)	55.0
Length up to fixing - (mm)	7.5
Fixing length - (mm)	2.0
EAN barcode	4779027393896



RD-5604

Outside diameter - Ø(mm)	56.0
Rim hole diameter - Ø(mm)	46.0
Sticker diameter - Ø(mm)	55.0
Length up to fixing - (mm)	10.5
Fixing length - (mm)	4.0
EAN barcode	4779027393902



RD-5605

Outside diameter - Ø(mm)	56.0
Rim hole diameter - Ø(mm)	54.0
Sticker diameter - Ø(mm)	55.0
Length up to fixing - (mm)	11.0
Fixing length - (mm)	3.0
EAN barcode	4779035322857

WHEELS CENTER CAPS



RD-5606

Outside diameter - Ø(mm)	56.0
Rim hole diameter - Ø(mm)	51.8
Sticker diameter - Ø(mm)	55.0
Length up to fixing - (mm)	9.0
Fixing length - (mm)	4.0
EAN barcode	4779035326787



RD-5701

Outside diameter - Ø(mm)	57.0
Rim hole diameter - Ø(mm)	51.5
Sticker diameter - Ø(mm)	56.0
Length up to fixing - (mm)	10.0
Fixing length - (mm)	4.5
EAN barcode	4779027392561



RD-5801

Outside diameter - Ø(mm)	57.5
Rim hole diameter - Ø(mm)	52.5
Sticker diameter - Ø(mm)	57.0
Length up to fixing - (mm)	11.0
Fixing length - (mm)	4.5
EAN barcode	4779027393544

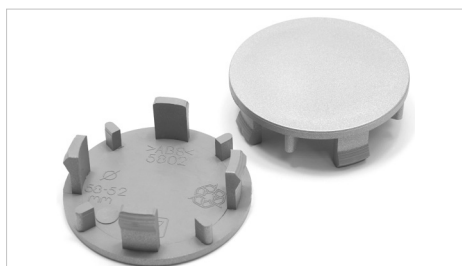

RD-5802

Outside diameter - Ø(mm)	57.5
Rim hole diameter - Ø(mm)	51.5
Sticker diameter - Ø(mm)	57.0
Length up to fixing - (mm)	15.5
Fixing length - (mm)	8.0
EAN barcode	4779035323427



RD-5803

Outside diameter - Ø(mm)	58.0
Rim hole diameter - Ø(mm)	56.5
Sticker diameter - Ø(mm)	57.0
Length up to fixing - (mm)	11.0
Fixing length - (mm)	5.0
EAN barcode	4779035323977



RD-5902

Outside diameter - Ø(mm)	59.0
Rim hole diameter - Ø(mm)	55.0
Sticker diameter - Ø(mm)	59.0
Length up to fixing - (mm)	9.5
Fixing length - (mm)	5.0
EAN barcode	4779027391823



RD-5903

Outside diameter - Ø(mm)	61.5
Rim hole diameter - Ø(mm)	48.0
Sticker diameter - Ø(mm)	61.0
Length up to fixing - (mm)	8.5
Fixing length - (mm)	2.5
EAN barcode	4779035320341



RD-6001

Outside diameter - Ø(mm)	60.0
Rim hole diameter - Ø(mm)	49.5
Sticker diameter - Ø(mm)	59.0
Length up to fixing - (mm)	12.5
Fixing length - (mm)	7.0
EAN barcode	4779027392462



RD-6002

Outside diameter - Ø(mm)	60.0
Rim hole diameter - Ø(mm)	54.0
Sticker diameter - Ø(mm)	59.0
Length up to fixing - (mm)	9.0
Fixing length - (mm)	4.5
EAN barcode	4779027392479



RD-6003

Outside diameter - Ø(mm)	59.5
Rim hole diameter - Ø(mm)	56.5
Sticker diameter - Ø(mm)	-
Length up to fixing - (mm)	6.5
Fixing length - (mm)	2.5
EAN barcode	4779027392547



RD-6004

Outside diameter - Ø(mm)	59.5
Rim hole diameter - Ø(mm)	56.0
Sticker diameter - Ø(mm)	59.0
Length up to fixing - (mm)	8.5
Fixing length - (mm)	3.5
EAN barcode	4779027392837



RD-6005

Outside diameter - Ø(mm)	60.0
Rim hole diameter - Ø(mm)	43.0
Sticker diameter - Ø(mm)	59.0
Length up to fixing - (mm)	11.5
Fixing length - (mm)	5.5
EAN barcode	4779027392844

WHEELS CENTER CAPS

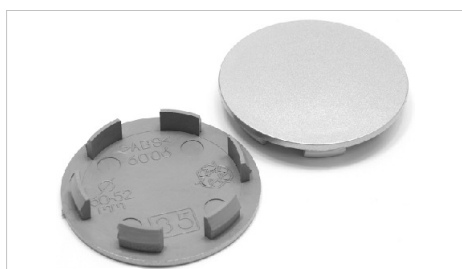

RD-6006

Outside diameter - Ø(mm)	59.0
Rim hole diameter - Ø(mm)	52.0
Sticker diameter - Ø(mm)	59.0
Length up to fixing - (mm)	8.0
Fixing length - (mm)	3.0
EAN barcode	4779027393919



RD-6007

Outside diameter - Ø(mm)	59.5
Rim hole diameter - Ø(mm)	46.5
Sticker diameter - Ø(mm)	59.0
Length up to fixing - (mm)	16.5
Fixing length - (mm)	10.5
EAN barcode	4779035320396



RD-6008

Outside diameter - Ø(mm)	60.0
Rim hole diameter - Ø(mm)	55.5
Sticker diameter - Ø(mm)	59.0
Length up to fixing - (mm)	10.0
Fixing length - (mm)	5.0
EAN barcode	4779035322703



RD-6009

Outside diameter - Ø(mm)	60.0
Rim hole diameter - Ø(mm)	56.0
Sticker diameter - Ø(mm)	59.0
Length up to fixing - (mm)	8.5
Fixing length - (mm)	2.5
EAN barcode	4779035322710



RD-6010

Outside diameter - Ø(mm)	60.0
Rim hole diameter - Ø(mm)	57.5
Sticker diameter - Ø(mm)	59.0
Length up to fixing - (mm)	10.5
Fixing length - (mm)	3.0
EAN barcode	4779035326763



RD-6011

Outside diameter - Ø(mm)	60.0
Rim hole diameter - Ø(mm)	55.0
Sticker diameter - Ø(mm)	54.0
Length up to fixing - (mm)	12.5
Fixing length - (mm)	6.0
EAN barcode	4779035327173



RD-6012

Outside diameter - Ø(mm)	60.0
Rim hole diameter - Ø(mm)	58.0
Sticker diameter - Ø(mm)	-
Length up to fixing - (mm)	11.5
Fixing length - (mm)	3.5
EAN barcode	4779035327449



RD-6013

Outside diameter - Ø(mm)	60.0
Rim hole diameter - Ø(mm)	56.5
Sticker diameter - Ø(mm)	59.0
Length up to fixing - (mm)	10.0
Fixing length - (mm)	6.0
EAN barcode	4779035327463



RD-6101

Outside diameter - Ø(mm)	60.5
Rim hole diameter - Ø(mm)	56.5
Sticker diameter - Ø(mm)	60.0
Length up to fixing - (mm)	11.5
Fixing length - (mm)	2.5
EAN barcode	4779027392530



RD-6102

Outside diameter - Ø(mm)	60.0
Rim hole diameter - Ø(mm)	56.0
Sticker diameter - Ø(mm)	39.0
Length up to fixing - (mm)	9.0
Fixing length - (mm)	4.5
EAN barcode	4779035324004



RD-6201

Outside diameter - Ø(mm)	61.5
Rim hole diameter - Ø(mm)	55.5
Sticker diameter - Ø(mm)	61.0
Length up to fixing - (mm)	7.0
Fixing length - (mm)	2.0
EAN barcode	4779027393926



RD-6202

Outside diameter - Ø(mm)	62.0
Rim hole diameter - Ø(mm)	60.0
Sticker diameter - Ø(mm)	60.0
Length up to fixing - (mm)	13.0
Fixing length - (mm)	9.0
EAN barcode	4779035326541

WHEELS CENTER CAPS



RD-6301

Outside diameter - Ø(mm)	63.0
Rim hole diameter - Ø(mm)	58.5
Sticker diameter - Ø(mm)	62.0
Length up to fixing - (mm)	7.5
Fixing length - (mm)	2.5
EAN barcode	4779027392448



RD-6302

Outside diameter - Ø(mm)	62.5
Rim hole diameter - Ø(mm)	57.0
Sticker diameter - Ø(mm)	61.0
Length up to fixing - (mm)	16.0
Fixing length - (mm)	8.0
EAN barcode	4779035320365



RD-6303

Outside diameter - Ø(mm)	62.5
Rim hole diameter - Ø(mm)	55.5
Sticker diameter - Ø(mm)	58.0
Length up to fixing - (mm)	6.5
Fixing length - (mm)	2.5
EAN barcode	4779035323984



RD-6304

Outside diameter - Ø(mm)	63.0
Rim hole diameter - Ø(mm)	54.0
Sticker diameter - Ø(mm)	62.0
Length up to fixing - (mm)	7.5
Fixing length - (mm)	4.0
EAN barcode	4779035326473



RD-6401

Outside diameter - Ø(mm)	68.0
Rim hole diameter - Ø(mm)	65.0
Sticker diameter - Ø(mm)	64.0
Length up to fixing - (mm)	11.0
Fixing length - (mm)	4.0
EAN barcode	4779027391830



RD-6402

Outside diameter - Ø(mm)	63.5
Rim hole diameter - Ø(mm)	61.0
Sticker diameter - Ø(mm)	63.0
Length up to fixing - (mm)	6.0
Fixing length - (mm)	2.5
EAN barcode	4779027393933

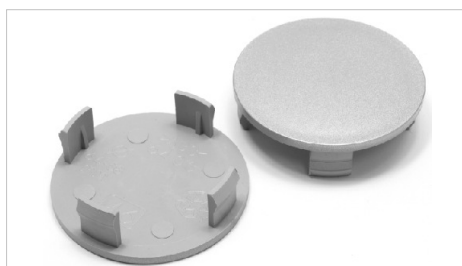

RD-6403

Outside diameter - Ø(mm)	63.0
Rim hole diameter - Ø(mm)	57.5
Sticker diameter - Ø(mm)	63.0
Length up to fixing - (mm)	14.5
Fixing length - (mm)	6.0
EAN barcode	4779035322864



RD-6404

Outside diameter - Ø(mm)	64.0
Rim hole diameter - Ø(mm)	58.0
Sticker diameter - Ø(mm)	63.0
Length up to fixing - (mm)	10.5
Fixing length - (mm)	4.5
EAN barcode	477903532677



RD-6501

Outside diameter - Ø(mm)	64.0
Rim hole diameter - Ø(mm)	61.5
Sticker diameter - Ø(mm)	64.0
Length up to fixing - (mm)	10.0
Fixing length - (mm)	4.0
EAN barcode	4779027392486



RD-6502

Outside diameter - Ø(mm)	64.5
Rim hole diameter - Ø(mm)	60.0
Sticker diameter - Ø(mm)	64.0
Length up to fixing - (mm)	11.5
Fixing length - (mm)	3.5
EAN barcode	4779027392523



RD-6503

Outside diameter - Ø(mm)	66.5
Rim hole diameter - Ø(mm)	56.0
Sticker diameter - Ø(mm)	66.0
Length up to fixing - (mm)	12.0
Fixing length - (mm)	4.0
EAN barcode	4779027393940

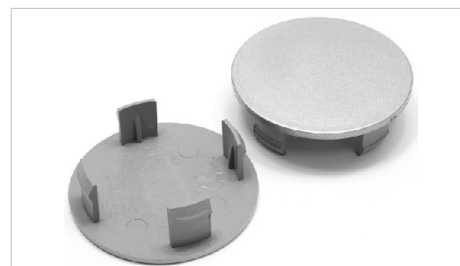

RD-6504

Outside diameter - Ø(mm)	64.5
Rim hole diameter - Ø(mm)	55.0
Sticker diameter - Ø(mm)	64.0
Length up to fixing - (mm)	17.5
Fixing length - (mm)	10.0
EAN barcode	4779035322871

WHEELS CENTER CAPS



RD-6505

Outside diameter - Ø(mm)	64.0
Rim hole diameter - Ø(mm)	57.0
Sticker diameter - Ø(mm)	63.0
Length up to fixing - (mm)	10.0
Fixing length - (mm)	5.0
EAN barcode	4779035323434



RD-6601

Outside diameter - Ø(mm)	66.0
Rim hole diameter - Ø(mm)	56.0
Sticker diameter - Ø(mm)	62.0
Length up to fixing - (mm)	7.0
Fixing length - (mm)	2.5
EAN barcode	4779035326756



RD-6701

Outside diameter - Ø(mm)	67.0
Rim hole diameter - Ø(mm)	56.0
Sticker diameter - Ø(mm)	66.0
Length up to fixing - (mm)	17.5
Fixing length - (mm)	13.0
EAN barcode	4779035326480



RD-6801

Outside diameter - Ø(mm)	68.0
Rim hole diameter - Ø(mm)	55.5
Sticker diameter - Ø(mm)	-
Length up to fixing - (mm)	11.0
Fixing length - (mm)	4.0
EAN barcode	4779027392578



RD-6802

Outside diameter - Ø(mm)	68.0
Rim hole diameter - Ø(mm)	62.5
Sticker diameter - Ø(mm)	59.0
Length up to fixing - (mm)	9.0
Fixing length - (mm)	3.5
EAN barcode	4779035323991



RD-6803

Outside diameter - Ø(mm)	67.5
Rim hole diameter - Ø(mm)	62.5
Sticker diameter - Ø(mm)	44.0
Length up to fixing - (mm)	8.5
Fixing length - (mm)	5.0
EAN barcode	4779035324011



RD-7001

Outside diameter - Ø(mm)	69.5
Rim hole diameter - Ø(mm)	63.0
Sticker diameter - Ø(mm)	69.0
Length up to fixing - (mm)	11.0
Fixing length - (mm)	5.0
EAN barcode	4779027392455



RD-7002

Outside diameter - Ø(mm)	69.5
Rim hole diameter - Ø(mm)	56.0
Sticker diameter - Ø(mm)	69.0
Length up to fixing - (mm)	12.0
Fixing length - (mm)	3.5
EAN barcode	4779027392516



RD-7003

Outside diameter - Ø(mm)	70.0
Rim hole diameter - Ø(mm)	67.0
Sticker diameter - Ø(mm)	69.0
Length up to fixing - (mm)	21.0
Fixing length - (mm)	9.5
EAN barcode	4779035320372



RD-7004

Outside diameter - Ø(mm)	70.0
Rim hole diameter - Ø(mm)	60.0
Sticker diameter - Ø(mm)	69.0
Length up to fixing - (mm)	12.5
Fixing length - (mm)	2.0
EAN barcode	4779035320389



RD-7401

Outside diameter - Ø(mm)	76.0
Rim hole diameter - Ø(mm)	58.5
Sticker diameter - Ø(mm)	75.0
Length up to fixing - (mm)	16.0
Fixing length - (mm)	8.5
EAN barcode	4779035320358



RD-7502

Outside diameter - Ø(mm)	75.0
Rim hole diameter - Ø(mm)	72.0
Sticker diameter - Ø(mm)	74.0
Length up to fixing - (mm)	14.0
Fixing length - (mm)	7.5
EAN barcode	4779027392424

BOLT CAPS



RD-7701

Outside diameter - Ø(mm)	76.5
Rim hole diameter - Ø(mm)	65.5
Sticker diameter - Ø(mm)	76.0
Fixing length - (mm)	12.5
Length up to fixing - (mm)	4.0
EAN barcode	4779027393957



RD-1701

Outside diameter - Ø(mm)	21.0
Rim hole diameter - Ø(mm)	17.0
Sticker diameter - Ø(mm)	26.0
Fixing length - (mm)	18.0
Length up to fixing - (mm)	Chrome
EAN barcode	4779035328606

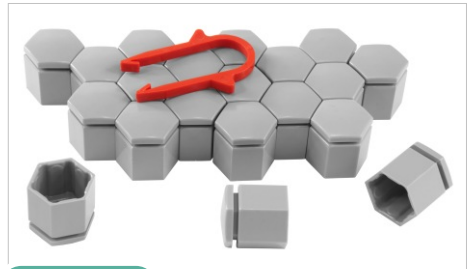

RD-1702

Outside diameter - Ø(mm)	21.0
Rim hole diameter - Ø(mm)	17.0
Sticker diameter - Ø(mm)	26.0
Fixing length - (mm)	18.0
Length up to fixing - (mm)	Grey
EAN barcode	4779035328613

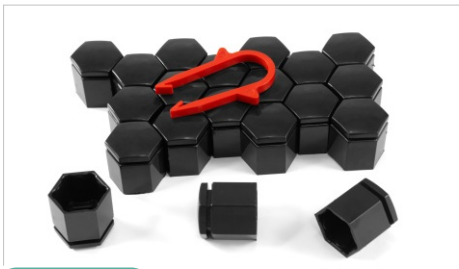

RD-1703

Outside diameter - Ø(mm)	21.0
Rim hole diameter - Ø(mm)	17.0
Sticker diameter - Ø(mm)	26.0
Fixing length - (mm)	18.0
Length up to fixing - (mm)	Black
EAN barcode	4779035328620



RD-1704

Outside diameter - Ø(mm)	21.0
Rim hole diameter - Ø(mm)	17.0
Sticker diameter - Ø(mm)	19.0
Fixing length - (mm)	15.0
Length up to fixing - (mm)	Chrome
EAN barcode	4779035328798



RD-1705

Outside diameter - Ø(mm)	21.0
Rim hole diameter - Ø(mm)	17.0
Sticker diameter - Ø(mm)	19.0
Fixing length - (mm)	15.0
Length up to fixing - (mm)	Black
EAN barcode	4779035328828



RD-1706

Outside diameter - Ø(mm)	21.0
Rim hole diameter - Ø(mm)	17.0
Sticker diameter - Ø(mm)	19.0
Fixing length - (mm)	15.0
Length up to fixing - (mm)	Red
EAN barcode	4779035328859

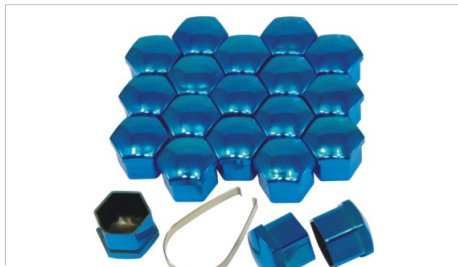

RD-1707

Outside diameter - Ø(mm)	21.0
Rim hole diameter - Ø(mm)	17.0
Sticker diameter - Ø(mm)	19.0
Fixing length - (mm)	15.0
Length up to fixing - (mm)	Blue
EAN barcode	4779035328880



RD-1708

Outside diameter - Ø(mm)	21.0
Rim hole diameter - Ø(mm)	17.0
Sticker diameter - Ø(mm)	19.0
Fixing length - (mm)	15.0
Length up to fixing - (mm)	Purple
EAN barcode	4779035328927

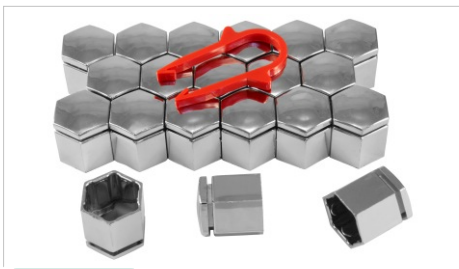

RD-1901

Outside diameter - Ø(mm)	23.0
Rim hole diameter - Ø(mm)	19.0
Sticker diameter - Ø(mm)	26.0
Fixing length - (mm)	18.0
Length up to fixing - (mm)	Chrome
EAN barcode	4779035328637

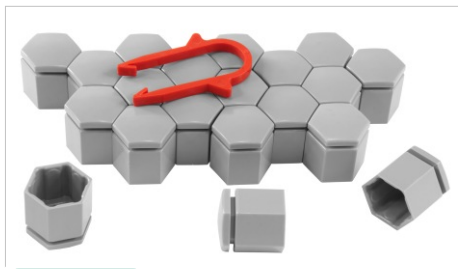

RD-1902

Outside diameter - Ø(mm)	23.0
Rim hole diameter - Ø(mm)	19.0
Sticker diameter - Ø(mm)	26.0
Fixing length - (mm)	18.0
Length up to fixing - (mm)	Grey
EAN barcode	4779035328644

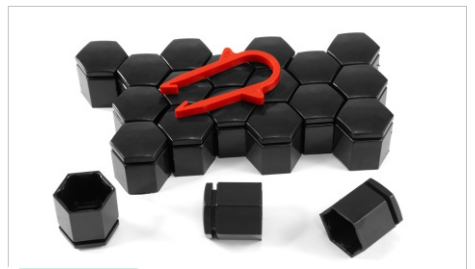

RD-1903

Outside diameter - Ø(mm)	23.0
Rim hole diameter - Ø(mm)	19.0
Sticker diameter - Ø(mm)	26.0
Fixing length - (mm)	18.0
Length up to fixing - (mm)	Black
EAN barcode	4779035328651

WHEEL BOLT CAPS



RD-1904

Outside diameter - Ø(mm)	22.0
Rim hole diameter - Ø(mm)	19.0
Sticker diameter - Ø(mm)	24.0
Fixing length - (mm)	19.0
Length up to fixing - (mm)	Chrome
EAN barcode	4779035328804



RD-1905

Outside diameter - Ø(mm)	22.0
Rim hole diameter - Ø(mm)	19.0
Sticker diameter - Ø(mm)	24.0
Fixing length - (mm)	19.0
Length up to fixing - (mm)	Black
EAN barcode	4779035328835



RD-1906

Outside diameter - Ø(mm)	22.0
Rim hole diameter - Ø(mm)	19.0
Sticker diameter - Ø(mm)	24.0
Fixing length - (mm)	19.0
Length up to fixing - (mm)	Red
EAN barcode	4779035328866



RD-1907

Outside diameter - Ø(mm)	22.0
Rim hole diameter - Ø(mm)	19.0
Sticker diameter - Ø(mm)	24.0
Fixing length - (mm)	19.0
Length up to fixing - (mm)	Blue
EAN barcode	4779035328897



RD-1908

Outside diameter - Ø(mm)	22.0
Rim hole diameter - Ø(mm)	19.0
Sticker diameter - Ø(mm)	24.0
Fixing length - (mm)	19.0
Length up to fixing - (mm)	Gold
EAN barcode	4779035328903



RD-1909

Outside diameter - Ø(mm)	22.0
Rim hole diameter - Ø(mm)	19.0
Sticker diameter - Ø(mm)	24.0
Fixing length - (mm)	19.0
Length up to fixing - (mm)	Purple
EAN barcode	4779035328934



RD-2101

Outside diameter - Ø(mm)	24.0
Rim hole diameter - Ø(mm)	21.0
Sticker diameter - Ø(mm)	24.0
Fixing length - (mm)	21.0
Length up to fixing - (mm)	Chrome
EAN barcode	4779035328811



RD-2102

Outside diameter - Ø(mm)	24.0
Rim hole diameter - Ø(mm)	21.0
Sticker diameter - Ø(mm)	24.0
Fixing length - (mm)	21.0
Length up to fixing - (mm)	Black
EAN barcode	4779035328842



RD-2103

Outside diameter - Ø(mm)	24.0
Rim hole diameter - Ø(mm)	21.0
Sticker diameter - Ø(mm)	24.0
Fixing length - (mm)	21.0
Length up to fixing - (mm)	Red
EAN barcode	4779035328873



RD-2104

Outside diameter - Ø(mm)	24.0
Rim hole diameter - Ø(mm)	21.0
Sticker diameter - Ø(mm)	24.0
Fixing length - (mm)	21.0
Length up to fixing - (mm)	Gold
EAN barcode	4779035328910



RD-2105

Outside diameter - Ø(mm)	24.0
Rim hole diameter - Ø(mm)	21.0
Sticker diameter - Ø(mm)	24.0
Fixing length - (mm)	21.0
Length up to fixing - (mm)	Silver
EAN barcode	4779035328941

3D DOMED POLYMER STICKERS



Diameter mm	Code	
49	3D-1496	3D-1496CH
51	3D-1000	3D-1000CH
53	3D-1001	3D-1001CH
54	3D-1002	3D-1002CH
55	3D-1003	3D-1003CH
56	3D-1004	3D-1004CH
57	3D-1005	3D-1005CH
58	3D-1393	3D-1393CH
59	3D-1006	3D-1006CH
60	3D-1007	3D-1007CH
61	3D-1211	3D-1211CH
62	3D-1008	3D-1008CH
64	3D-1009	3D-1009CH
65	3D-1394	3D-1394CH
66	3D-1010	3D-1010CH
68	3D-1011	3D-1011CH
69	3D-1212	3D-1212CH
70	3D-1395	3D-1395CH
74	3D-1012	3D-1012CH
75	3D-1213	3D-1213CH
76	3D-1214	3D-1214CH
80	3D-1396	3D-1396CH
90	3D-1397	3D-1397CH
120	3D-1013	3D-1013CH



Diameter mm	Code	
49	3D-1497	3D-1497CH
51	3D-1014	3D-1014CH
53	3D-1015	3D-1015CH
54	3D-1016	3D-1016CH
55	3D-1017	3D-1017CH
56	3D-1018	3D-1018CH
57	3D-1019	3D-1019CH
58	3D-1398	3D-1398CH
59	3D-1020	3D-1020CH
60	3D-1021	3D-1021CH
61	3D-1215	3D-1215CH
62	3D-1022	3D-1022CH
64	3D-1023	3D-1023CH
65	3D-1399	3D-1399CH
66	3D-1024	3D-1024CH
68	3D-1025	3D-1025CH
69	3D-1216	3D-1216CH
70	3D-1400	3D-1400CH
74	3D-1026	3D-1026CH
75	3D-1217	3D-1217CH
76	3D-1218	3D-1218CH
80	3D-1401	3D-1401CH
90	3D-1402	3D-1402CH
120	3D-1027	3D-1027CH



Diameter mm	Code	
49	3D-1498	3D-1498CH
51	3D-1028	3D-1028CH
53	3D-1029	3D-1029CH
54	3D-1030	3D-1030CH
55	3D-1031	3D-1031CH
56	3D-1032	3D-1032CH
57	3D-1033	3D-1033CH
58	3D-1403	3D-1403CH
59	3D-1034	3D-1034CH
60	3D-1035	3D-1035CH
61	3D-1219	3D-1219CH
62	3D-1036	3D-1036CH
64	3D-1037	3D-1037CH
65	3D-1404	3D-1404CH
66	3D-1038	3D-1038CH
68	3D-1039	3D-1039CH
69	3D-1220	3D-1220CH
70	3D-1405	3D-1405CH
74	3D-1040	3D-1040CH
75	3D-1221	3D-1221CH
76	3D-1222	3D-1222CH
80	3D-1406	3D-1406CH
90	3D-1407	3D-1407CH
120	3D-1041	3D-1041CH



Diameter mm	Code	
49	3D-1499	3D-1499CH
51	3D-1042	3D-1042CH
53	3D-1043	3D-1043CH
54	3D-1044	3D-1044CH
55	3D-1045	3D-1045CH
56	3D-1046	3D-1046CH
57	3D-1047	3D-1047CH
58	3D-1408	3D-1408CH
59	3D-1048	3D-1048CH
60	3D-1049	3D-1049CH
61	3D-1223	3D-1223CH
62	3D-1050	3D-1050CH
64	3D-1051	3D-1051CH
65	3D-1409	3D-1409CH
66	3D-1052	3D-1052CH
68	3D-1053	3D-1053CH
69	3D-1224	3D-1224CH
70	3D-1410	3D-1410CH
74	3D-1054	3D-1054CH
75	3D-1225	3D-1225CH
76	3D-1226	3D-1226CH
80	3D-1411	3D-1411CH
90	3D-1412	3D-1412CH
120	3D-1055	3D-1055CH



Diameter mm	Code	
49	3D-1500	3D-1500CH
51	3D-1056	3D-1056CH
53	3D-1057	3D-1057CH
54	3D-1058	3D-1058CH
55	3D-1059	3D-1059CH
56	3D-1060	3D-1060CH
57	3D-1061	3D-1061CH
58	3D-1413	3D-1413CH
59	3D-1062	3D-1062CH
60	3D-1063	3D-1063CH
61	3D-1227	3D-1227CH
62	3D-1064	3D-1064CH
64	3D-1065	3D-1065CH
65	3D-1414	3D-1414CH
66	3D-1066	3D-1066CH
68	3D-1067	3D-1067CH
69	3D-1228	3D-1228CH
70	3D-1415	3D-1415CH
74	3D-1068	3D-1068CH
75	3D-1229	3D-1229CH
76	3D-1230	3D-1230CH
80	3D-1416	3D-1416CH
90	3D-1417	3D-1417CH
120	3D-1069	3D-1069CH



Diameter mm	Code	
49	3D-1501	3D-1501CH
51	3D-1070	3D-1070CH
53	3D-1071	3D-1071CH
54	3D-1072	3D-1072CH
55	3D-1073	3D-1073CH
56	3D-1074	3D-1074CH
57	3D-1075	3D-1075CH
58	3D-1418	3D-1418CH
59	3D-1076	3D-1076CH
60	3D-1077	3D-1077CH
61	3D-1231	3D-1231CH
62	3D-1078	3D-1078CH
64	3D-1079	3D-1079CH
65	3D-1419	3D-1419CH
66	3D-1080	3D-1080CH
68	3D-1081	3D-1081CH
69	3D-1232	3D-1232CH
70	3D-1420	3D-1420CH
74	3D-1082	3D-1082CH
75	3D-1233	3D-1233CH
76	3D-1234	3D-1234CH
80	3D-1421	3D-1421CH
90	3D-1422	3D-1422CH
120	3D-1083	3D-1083CH



Diameter mm	Code	
49	3D-1502	3D-1502CH
51	3D-1084	3D-1084CH
53	3D-1085	3D-1085CH
54	3D-1086	3D-1086CH
55	3D-1087	3D-1087CH
56	3D-1088	3D-1088CH
57	3D-1089	3D-1089CH
58	3D-1423	3D-1423CH
59	3D-1090	3D-1090CH
60	3D-1091	3D-1091CH
61	3D-1235	3D-1235CH
62	3D-1092	3D-1092CH
64	3D-1093	3D-1093CH
65	3D-1424	3D-1424CH
66	3D-1094	3D-1094CH
68	3D-1095	3D-1095CH
69	3D-1236	3D-1236CH
70	3D-1425	3D-1425CH
74	3D-1096	3D-1096CH
75	3D-1237	3D-1237CH
76	3D-1238	3D-1238CH
80	3D-1426	3D-1426CH
90	3D-1427	3D-1427CH
120	3D-1097	3D-1097CH

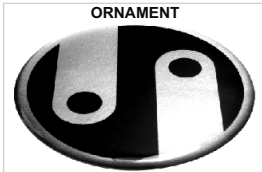

Diameter mm	Code	
49	3D-1503	3D-1503CH
51	3D-1098	3D-1098CH
53	3D-1099	3D-1099CH
54	3D-1100	3D-1100CH
55	3D-1102	3D-1102CH
56	3D-1103	3D-1103CH
57	3D-1104	3D-1104CH
58	3D-1428	3D-1428CH
59	3D-1105	3D-1105CH
60	3D-1106	3D-1106CH
61	3D-1239	3D-1239CH
62	3D-1107	3D-1107CH
64	3D-1108	3D-1108CH
65	3D-1429	3D-1429CH
66	3D-1109	3D-1109CH
68	3D-1110	3D-1110CH
69	3D-1240	3D-1240CH
70	3D-1430	3D-1430CH
74	3D-1111	3D-1111CH
75	3D-1241	3D-1241CH
76	3D-1242	3D-1242CH
80	3D-1431	3D-1431CH
90	3D-1432	3D-1432CH
120	3D-1112	3D-1112CH



Diameter mm	Code	
49	3D-1504	3D-1504CH
51	3D-1113	3D-1113CH
53	3D-1114	3D-1114CH
54	3D-1115	3D-1115CH
55	3D-1116	3D-1116CH
56	3D-1117	3D-1117CH
57	3D-1118	3D-1118CH
58	3D-1433	3D-1433CH
59	3D-1119	3D-1119CH
60	3D-1120	3D-1120CH
61	3D-1243	3D-1243CH
62	3D-1121	3D-1121CH
64	3D-1122	3D-1122CH
65	3D-1434	3D-1434CH
66	3D-1123	3D-1123CH
68	3D-1124	3D-1124CH
69	3D-1244	3D-1244CH
70	3D-1435	3D-1435CH
74	3D-1125	3D-1125CH
75	3D-1245	3D-1245CH
76	3D-1246	3D-1246CH
80	3D-1436	3D-1436CH
90	3D-1437	3D-1437CH
120	3D-1126	3D-1126CH



Diameter mm	Code	
49	3D-1505	3D-1505CH
51	3D-1127	3D-1127CH
53	3D-1128	3D-1128CH
54	3D-1129	3D-1129CH
55	3D-1130	3D-1130CH
56	3D-1131	3D-1131CH
57	3D-1132	3D-1132CH
58	3D-1438	3D-1438CH
59	3D-1133	3D-1133CH
60	3D-1134	3D-1134CH
61	3D-1247	3D-1247CH
62	3D-1135	3D-1135CH
64	3D-1136	3D-1136CH
65	3D-1439	3D-1439CH
66	3D-1137	3D-1137CH
68	3D-1138	3D-1138CH
69	3D-1248	3D-1248CH
70	3D-1440	3D-1440CH
74	3D-1139	3D-1139CH
75	3D-1249	3D-1249CH
76	3D-1250	3D-1250CH
80	3D-1441	3D-1441CH
90	3D-1442	3D-1442CH
120	3D-1140	3D-1140CH



Diameter mm	Code	
49	3D-1506	3D-1506CH
51	3D-1275	3D-1275CH
53	3D-1276	3D-1276CH
54	3D-1277	3D-1277CH
55	3D-1278	3D-1278CH
56	3D-1279	3D-1279CH
57	3D-1280	3D-1280CH
58	3D-1443	3D-1443CH
59	3D-1281	3D-1281CH
60	3D-1282	3D-1282CH
61	3D-1251	3D-1251CH
62	3D-1283	3D-1283CH
64	3D-1284	3D-1284CH
65	3D-1444	3D-1444CH
66	3D-1285	3D-1285CH
68	3D-1286	3D-1286CH
69	3D-1252	3D-1252CH
70	3D-1445	3D-1445CH
74	3D-1287	3D-1287CH
75	3D-1253	3D-1253CH
76	3D-1254	3D-1254CH
80	3D-1446	3D-1446CH
90	3D-1447	3D-1447CH
120	3D-1288	3D-1288CH



Diameter mm	Code	
49	3D-1507	3D-1507CH
51	3D-1141	3D-1141CH
53	3D-1142	3D-1142CH
54	3D-1143	3D-1143CH
55	3D-1144	3D-1144CH
56	3D-1145	3D-1145CH
57	3D-1146	3D-1146CH
58	3D-1448	3D-1448CH
59	3D-1147	3D-1147CH
60	3D-1148	3D-1148CH
61	3D-1255	3D-1255CH
62	3D-1149	3D-1149CH
64	3D-1150	3D-1150CH
65	3D-1449	3D-1449CH
66	3D-1151	3D-1151CH
68	3D-1152	3D-1152CH
69	3D-1256	3D-1256CH
70	3D-1450	3D-1450CH
74	3D-1153	3D-1153CH
75	3D-1257	3D-1257CH
76	3D-1258	3D-1258CH
80	3D-1451	3D-1451CH
90	3D-1452	3D-1452CH
120	3D-1154	3D-1154CH



Diameter mm	Code	
49	3D-1508	3D-1508CH
51	3D-1155	3D-1155CH
53	3D-1156	3D-1156CH
54	3D-115	

3D DOMED POLYMER STICKERS

DECOR

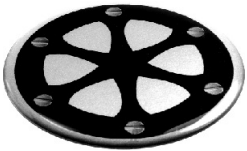

Diameter mm	Code	
49	3D-1511	3D-1511CH
51	3D-1197	3D-1197CH
53	3D-1198	3D-1198CH
54	3D-1199	3D-1199CH
55	3D-1200	3D-1200CH
56	3D-1201	3D-1201CH
57	3D-1202	3D-1202CH
58	3D-1468	3D-1468CH
59	3D-1203	3D-1203CH
60	3D-1204	3D-1204CH
61	3D-1271	3D-1271CH
62	3D-1205	3D-1205CH
64	3D-1206	3D-1206CH
65	3D-1469	3D-1469CH
66	3D-1207	3D-1207CH
68	3D-1208	3D-1208CH
69	3D-1272	3D-1272CH
70	3D-1470	3D-1470CH
74	3D-1209	3D-1209CH
75	3D-1273	3D-1273CH
76	3D-1274	3D-1274CH
80	3D-1471	3D-1471CH
90	3D-1472	3D-1472CH
120	3D-1210	3D-1210CH

BLACK



Diameter mm	Code	
49	3D-1512	
51	3D-1301	
53	3D-1302	
54	3D-1303	
55	3D-1304	
56	3D-1305	
57	3D-1306	
58	3D-1377	
59	3D-1307	
60	3D-1308	
61	3D-1309	
62	3D-1310	
64	3D-1311	
65	3D-1378	
66	3D-1312	
68	3D-1313	
69	3D-1314	
70	3D-1379	
74	3D-1315	
75	3D-1316	
76	3D-1317	
80	3D-1380	
90	3D-1390	
120	3D-1318	

SILVER

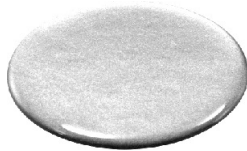

Diameter mm	Code	
49	3D-1513	
51	3D-1319	
53	3D-1320	
54	3D-1321	
55	3D-1322	
56	3D-1323	
57	3D-1324	
58	3D-1381	
59	3D-1325	
60	3D-1326	
61	3D-1327	
62	3D-1328	
64	3D-1329	
65	3D-1382	
66	3D-1330	
68	3D-1331	
69	3D-1332	
70	3D-1383	
74	3D-1333	
75	3D-1334	
76	3D-1335	
80	3D-1384	
90	3D-1391	
120	3D-1336	

CHROME



Diameter mm	Code	
49	3D-1514	
51	3D-1337	
53	3D-1338	
54	3D-1339	
55	3D-1340	
56	3D-1341	
57	3D-1342	
58	3D-1385	
59	3D-1343	
60	3D-1344	
61	3D-1345	
62	3D-1346	
64	3D-1347	
65	3D-1386	
66	3D-1348	
68	3D-1349	
69	3D-1350	
70	3D-1387	
74	3D-1351	
75	3D-1352	
76	3D-1353	
80	3D-1388	
90	3D-1392	
120	3D-1354	

BRUSHED METAL

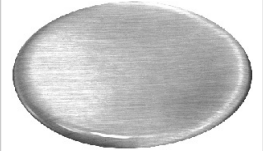

Diameter mm	Code	
49	3D-1515	
51	3D-1355	
53	3D-1356	
54	3D-1357	
55	3D-1358	
56	3D-1359	
57	3D-1360	
58	3D-1361	
59	3D-1362	
60	3D-1363	
61	3D-1364	
62	3D-1365	
64	3D-1366	
65	3D-1367	
66	3D-1368	
68	3D-1369	
69	3D-1370	
70	3D-1371	
74	3D-1372	
75	3D-1373	
76	3D-1374	
80	3D-1375	
90	3D-1389	
120	3D-1376	

CARBON



Diameter mm	Code	
49	3D-1516	
51	3D-1473	
53	3D-1474	
54	3D-1475	
55	3D-1476	
56	3D-1477	
57	3D-1478	
58	3D-1479	
59	3D-1480	
60	3D-1481	
61	3D-1482	
62	3D-1483	
64	3D-1484	
65	3D-1485	
66	3D-1486	
68	3D-1487	
69	3D-1488	
70	3D-1489	
74	3D-1490	
75	3D-1491	
76	3D-1492	
80	3D-1493	
90	3D-1494	
120	3D-1495	

CH - sticker on chrome base

BOLTS AND NUTS

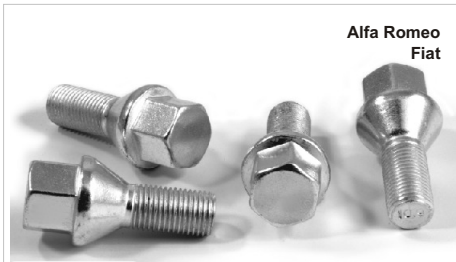
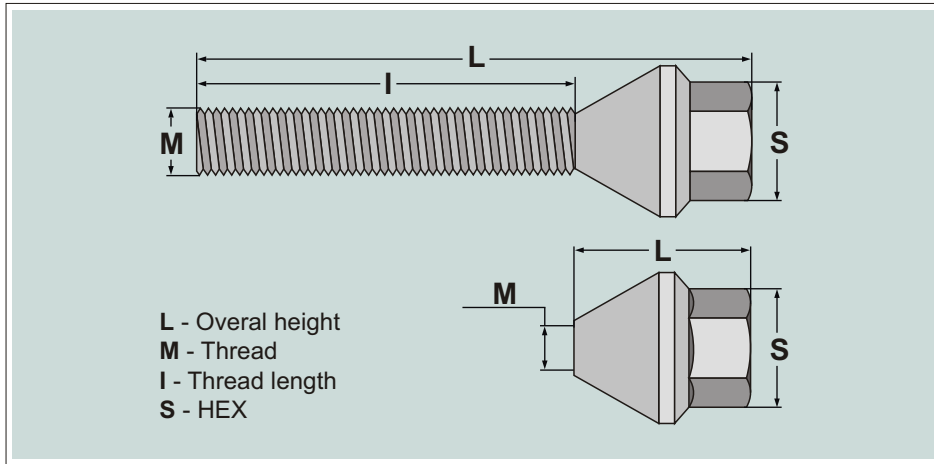

Alfa Romeo
Fiat

RV-0201

Thread length (mm)	22.0
Thread(mm)	M 12x1.25
Overall height (mm)	47.0
HEX	17
Quality	10.9
Lug seat type	conical
Finish	zinc plated

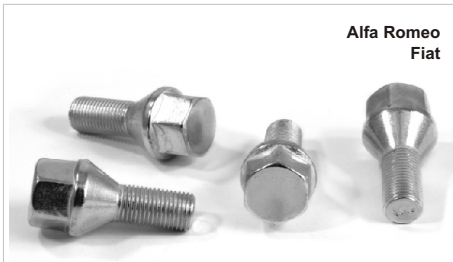

Alfa Romeo
Fiat

RV-0202

Thread length (mm)	22.0
Thread(mm)	M 12x1.25
Overall height (mm)	48.0
HEX	19
Quality	10.9
Lug seat type	conical
Finish	zinc plated



RV-0203

Thread length (mm)	26.0
Thread(mm)	M 12x1.25
Overall height (mm)	46.0
HEX	17
Quality	10.9
Lug seat type	conical
Finish	zinc plated



RV-0204

Thread length (mm)	26.0
Thread(mm)	M 12x1.25
Overall height (mm)	44.0
HEX	19
Quality	10.9
Lug seat type	conical
Finish	zinc plated



RV-0205

Thread length (mm)	28.0
Thread(mm)	M 12x1.25
Overall height (mm)	48.0
HEX	17
Quality	10.9
Lug seat type	conical
Finish	zinc plated



Peugeot
Citroen

RV-0206

Thread length (mm)	20.0
Thread(mm)	M 12x1.5
Overall height (mm)	41.0
HEX	17
Quality	10.9
Lug seat type	conical
Finish	zinc plated



Mercedes-Benz (R12)

RV-0207

Thread length (mm)	21.0
Thread(mm)	M 12x1.5
Overall height (mm)	39.0
HEX	17
Quality	10.9
Lug seat type	spherical collar
Finish	zinc plated



Opel

RV-0208

Thread length (mm)	22.0
Thread(mm)	M 12x1.5
Overall height (mm)	48.0
HEX	17
Quality	10.9
Lug seat type	conical
Finish	zinc plated



Opel
Renault

RV-0209

Thread length (mm)	24.0
Thread(mm)	M 12x1.5
Overall height (mm)	44.0
HEX	17
Quality	10.9
Lug seat type	conical
Finish	zinc plated

BOLTS AND NUTS



RV-0210

Thread length (mm)	26.0
Thread(mm)	M 12x1.5
Overall height (mm)	57.0
HEX	17
Quality	10.9
Lug seat type	conical
Finish	chrome plated



RV-0211

Thread length (mm)	28.0
Thread(mm)	M 12x1.5
Overall height (mm)	48.0
HEX	17
Quality	10.9
Lug seat type	conical
Finish	zinc plated



RV-0212

Thread length (mm)	30.0
Thread(mm)	M 12x1.5
Overall height (mm)	50.0
HEX	17
Quality	10.9
Lug seat type	conical
Finish	zinc plated



RV-0213

Thread length (mm)	35.0
Thread(mm)	M 12x1.5
Overall height (mm)	57.0
HEX	17
Quality	8.8
Lug seat type	conical
Finish	chrome plated



RV-0214

Thread length (mm)	40.0
Thread(mm)	M 12x1.5
Overall height (mm)	67.0
HEX	17
Quality	10.9
Lug seat type	conical
Finish	zinc plated



Mercedes-Benz (R12)

RV-0215

Thread length (mm)	40.0
Thread(mm)	M 12x1.5
Overall height (mm)	58.0
HEX	17
Quality	10.9
Lug seat type	spherical collar
Finish	zinc plated



Audi (R13)

RV-0401

Thread length (mm)	27.0
Thread(mm)	M 14x1.5
Overall height (mm)	48.0
HEX	17
Quality	10.9
Lug seat type	spherical collar
Finish	zinc plated



RV-0402

Thread length (mm)	28.0
Thread(mm)	M 14x1.5
Overall height (mm)	47.0
HEX	17
Quality	10.9
Lug seat type	conical
Finish	zinc plated



RV-0403

Thread length (mm)	30.0
Thread(mm)	M 14x1.5
Overall height (mm)	49.0
HEX	17
Quality	10.9
Lug seat type	conical
Finish	zinc plated



RV-0404

Thread length (mm)	40.0
Thread(mm)	M 14x1.5
Overall height (mm)	59.0
HEX	17
Quality	10.9
Lug seat type	conical
Finish	zinc plated



BMW

RV-0405

Thread length (mm)	28.0
Thread(mm)	M 14x1.25
Overall height (mm)	53.0
HEX	17
Quality	10.9
Lug seat type	conical
Finish	chrome plated

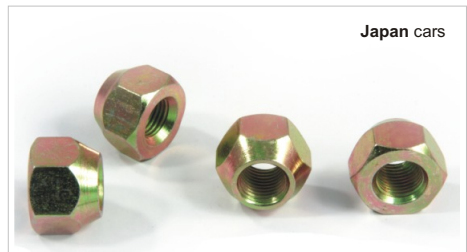

Japan cars

RV-0001

Thread length (mm)	16.0
Thread(mm)	M 12x1.25
Overall height (mm)	16.0
HEX	21
Quality	10.9
Lug seat type	conical
Finish	zinc plated

BOLTS AND NUTS



RV-0002

Thread length (mm)	32.0
Thread(mm)	M 12x1.25
Overall height (mm)	35.0
HEX	19
Quality	10.9
Lug seat type	conical
Finish	chrome plated



Ford

RV-0003

Thread length (mm)	16.0
Thread(mm)	M 12x1.5
Overall height (mm)	16.0
HEX	19
Quality	10.9
Lug seat type	conical
Finish	zinc plated

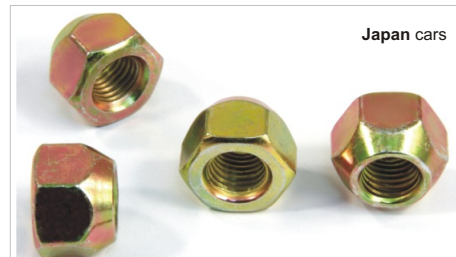

Japan cars

RV-0004

Thread length (mm)	16.0
Thread(mm)	M 12x1.5
Overall height (mm)	16.0
HEX	21
Quality	10.9
Lug seat type	conical
Finish	zinc plated



RV-0005

Thread length (mm)	32.0
Thread(mm)	M 12x1.5
Overall height (mm)	34.0
HEX	17
Quality	10.9
Lug seat type	conical
Finish	zinc plated



RV-0006

Thread length (mm)	33.0
Thread(mm)	M 12x1.5
Overall height (mm)	35.0
HEX	19
Quality	10.9
Lug seat type	conical
Finish	chrome plated

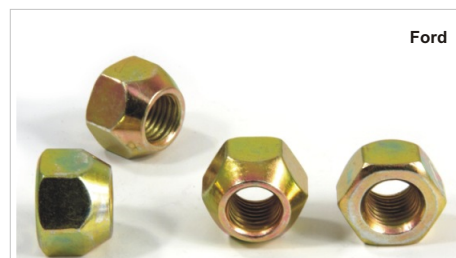

Ford

RV-0007

Thread length (mm)	16.0
Thread(mm)	M 14x1.5
Overall height (mm)	16.0
HEX	21
Quality	10.9
Lug seat type	conical
Finish	zinc plated



Ford

RV-0008

Thread length (mm)	33.0
Thread(mm)	M 12x1.5
Overall height (mm)	35.0
HEX	19
Quality	10.9
Lug seat type	moving conical
Finish	chrome plated

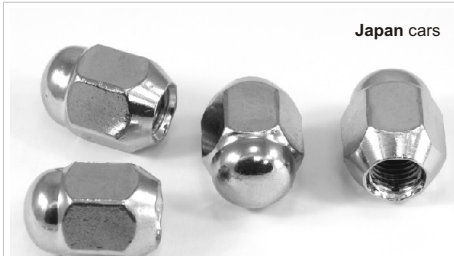

Japan cars

RV-0009

Thread length (mm)	27.0
Thread(mm)	M 12x1.5
Overall height (mm)	30.0
HEX	21
Quality	10.9
Lug seat type	conical
Finish	chrome plated



Ford 2016-2015 (Galaxy, S-Max)

RV-0010

Thread length (mm)	33.0
Thread(mm)	M 14x1.5
Overall height (mm)	35.0
HEX	19
Quality	10.9
Lug seat type	conical
Finish	chrome plated



USA cars

RV-0011

Thread length (mm)	33.0
Thread(mm)	M 1/2-20
Overall height (mm)	35.0
HEX	19
Quality	10.9
Lug seat type	conical
Finish	chrome plated



Toyota

RV-0012

Thread length (mm)	33.0
Thread(mm)	M 12x1.5
Overall height (mm)	37.0
HEX	21
Quality	10.9
Lug seat type	conical
Finish	chrome plated



Honda

RV-0013

Thread length (mm)	19.0
Thread(mm)	M 12x1.5
Overall height (mm)	19.0
HEX	19
Quality	10.9
Lug seat type	spherical collar
Finish	chrome plated

SPACERS



RK-0301



RK-0501



RK-0801



RK-0802



RK-0806



RK-0603

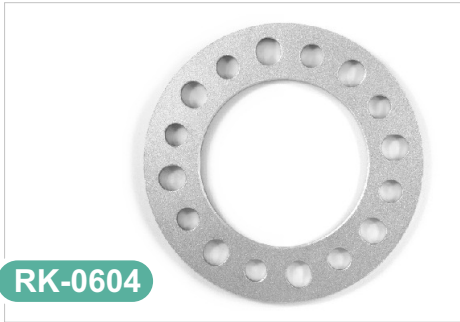

RK-0604



RK-0502



RK-0803



RK-1001



RK-1301



PCD-01

Nr.	Code	Number of mounting holes	PCD	Inner diameter I.D. (mm)	Outer diameter O.D. (mm)	Thickness (mm)
1	RK-0301	4 / 5	98.0 - 120.0	78.0	151.0	3.0
2	RK-0501	4 / 5	98.0 - 120.0	78.0	151.0	5.0
3	RK-0801	4 / 5	98.0 - 120.0	78.0	151.0	8.0
4	RK-0802	4	98.0 - 120.0	71.5	151.5	8.0
5	RK-0806	5	108.0 - 120.0	90.0	164.3	8.0
6	RK-0603	5 / 6	135.0 - 139.7	107.0	178.0	6.0
7	RK-0604	8	165.1 - 170.0	127.0	208.0	6.0
8	RK-0502	4 / 5	98.0 - 120.0	78.5	145.0	5.0
9	RK-0803	4 / 5	98.0 - 120.0	78.5	145.0	8.0
10	RK-1001	4 / 5	98.0 - 120.0	78.5	145.0	10.0
11	RK-1301	5	108.0 - 120.0	82.0	155.0	12.7

HOW TO MEASURE PCD

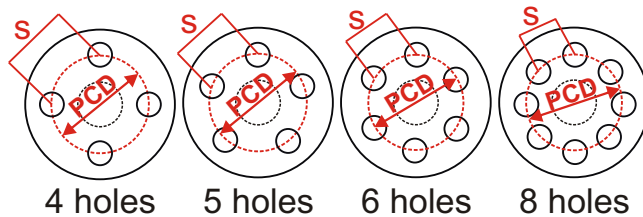

The actual appearance of the product may sometimes differ from the image.
The delivered goods are spare parts. The names of cars and original numbers are for information purposes only.

WHEEL BALANCE WEIGHTS

Hammered balancing weights for steel rims

For all steel rims with smooth, rolled or semi-rolled edges

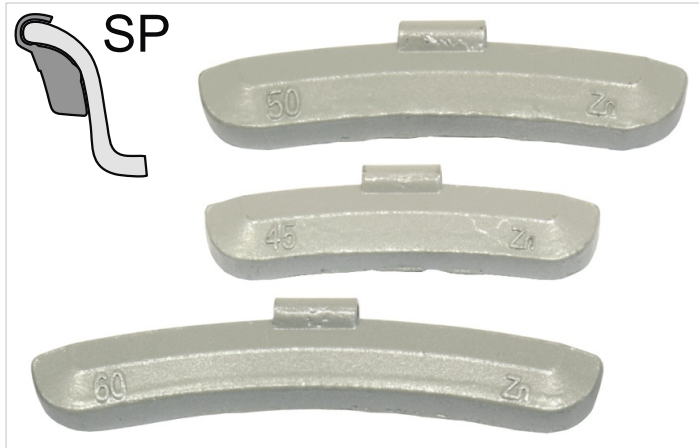

Nr.	Code	Weight	Material	Package	The purpose of the weight
1	SP-005G	5 g.	Zinc	100 pcs	Steel rims
2	SP-010G	10 g.	Zinc	100 pcs	Steel rims
3	SP-015G	15 g.	Zinc	100 pcs	Steel rims
4	SP-020G	20 g.	Zinc	100 pcs	Steel rims
5	SP-025G	25 g.	Zinc	100 pcs	Steel rims
6	SP-030G	30 g.	Zinc	100 pcs	Steel rims
7	SP-035G	35 g.	Zinc	50 pcs	Steel rims
8	SP-040G	40 g.	Zinc	50 pcs	Steel rims
9	SP-045G	45 g.	Zinc	50 pcs	Steel rims
10	SP-050G	50 g.	Zinc	50 pcs	Steel rims
11	SP-055G	55 g.	Zinc	50 pcs	Steel rims
12	SP-060G	60 g.	Zinc	50 pcs	Steel rims

Hammered balancing weights for alloy rims

For all aluminum rims with smooth, rolled or semi-rolled edges



Nr.	Code	Weight	Material	Package	The purpose of the weight
1	SA-005G	5 g.	Zinc	100 pcs	Cast aluminum alloy rims
2	SA-010G	10 g.	Zinc	100 pcs	Cast aluminum alloy rims
3	SA-015G	15 g.	Zinc	100 pcs	Cast aluminum alloy rims
4	SA-020G	20 g.	Zinc	100 pcs	Cast aluminum alloy rims
5	SA-025G	25 g.	Zinc	100 pcs	Cast aluminum alloy rims
6	SA-030G	30 g.	Zinc	100 pcs	Cast aluminum alloy rims
7	SA-035G	35 g.	Zinc	50 pcs	Cast aluminum alloy rims
8	SA-040G	40 g.	Zinc	50 pcs	Cast aluminum alloy rims
9	SA-045G	45 g.	Zinc	50 pcs	Cast aluminum alloy rims
10	SA-050G	50 g.	Zinc	50 pcs	Cast aluminum alloy rims
11	SA-055G	55 g.	Zinc	50 pcs	Cast aluminum alloy rims
12	SA-060G	60 g.	Zinc	50 pcs	Cast aluminum alloy rims

Adhesive weights for wheel balancing

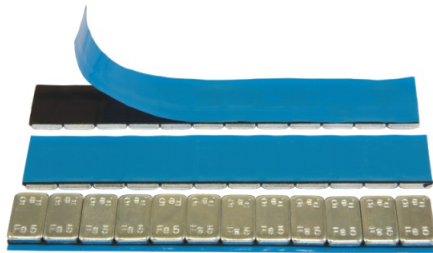

SL-0001

Material	Steel
Weight (g)	5.0
Amount.)	12
Surface	Zinc plated
Packaging (strips)	100

Adhesive weights for wheel balancing

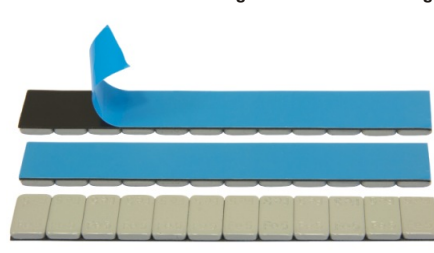

SL-0002

Material	Steel
Weight (g)	5.0
Amount.)	12
Surface	Plastic
Packaging (strips)	100

TYRE AIR VALVE CAPS



VC-0001



VC-0002



VC-0003

The actual appearance of the product may sometimes differ from the image.
The delivered goods are spare parts. The names of cars and original numbers are for information purposes only.

TYRE AIR VALVE CAPS



VC-0004



VC-0005



VC-0006



VC-0007



VC-0008



VC-0009



VC-0010



VC-0011



VC-0012



VC-0013

The actual appearance of the product may sometimes differ from the image.
The delivered goods are spare parts. The names of cars and original numbers are for information purposes only.

The actual appearance of the product may sometimes differ from the image.
The delivered goods are spare parts. The names of cars and original numbers are for information purposes only.

AUTOAKSESUARAI

ACCESSORIES FOR YOUR CAR

- > LICENSE PLATE FRAMES
- > WHEELS ACCESSORIES
- > STICKERS
- > DOMED POLYMER STICKERS
- > AUTO FASTENERS
- > PIPE CONNECTORS
- > PROTECTIVE RUBBER
- > PLASTIC BUSHES OF STEERING-WHEEL TRACTION AND JOINTS

www.autoremeliai.lt



WHOLESALE TRADE AND COOPERATION

Tel.: +370 616 22155
komercija@autoremeliai.lt
www.autoremeliai.lt